

AMERICAN ARMED SCHOONER  
HANNAH

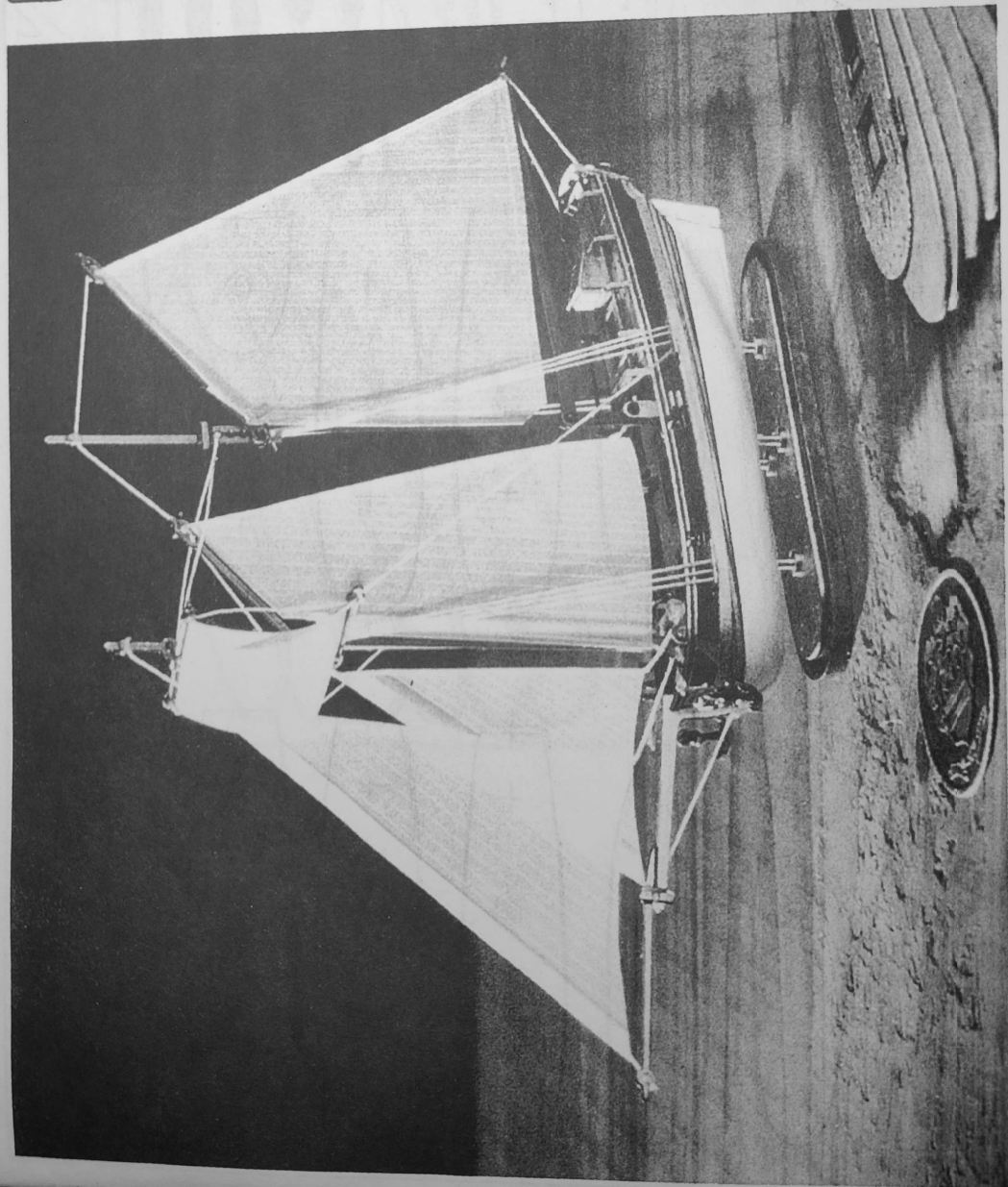

# HANNAH

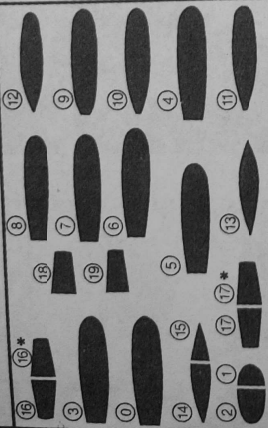

**ATTENTION!**  
All the pieces should be glued to each other in numerical order, (number 1 onto number 2, then onto number 3, and so on).

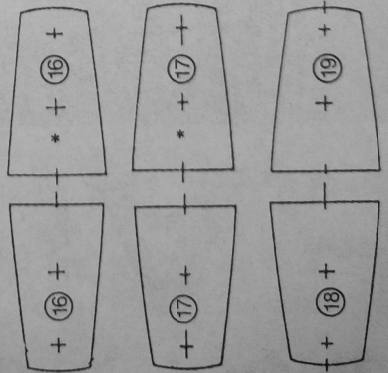

\* optional

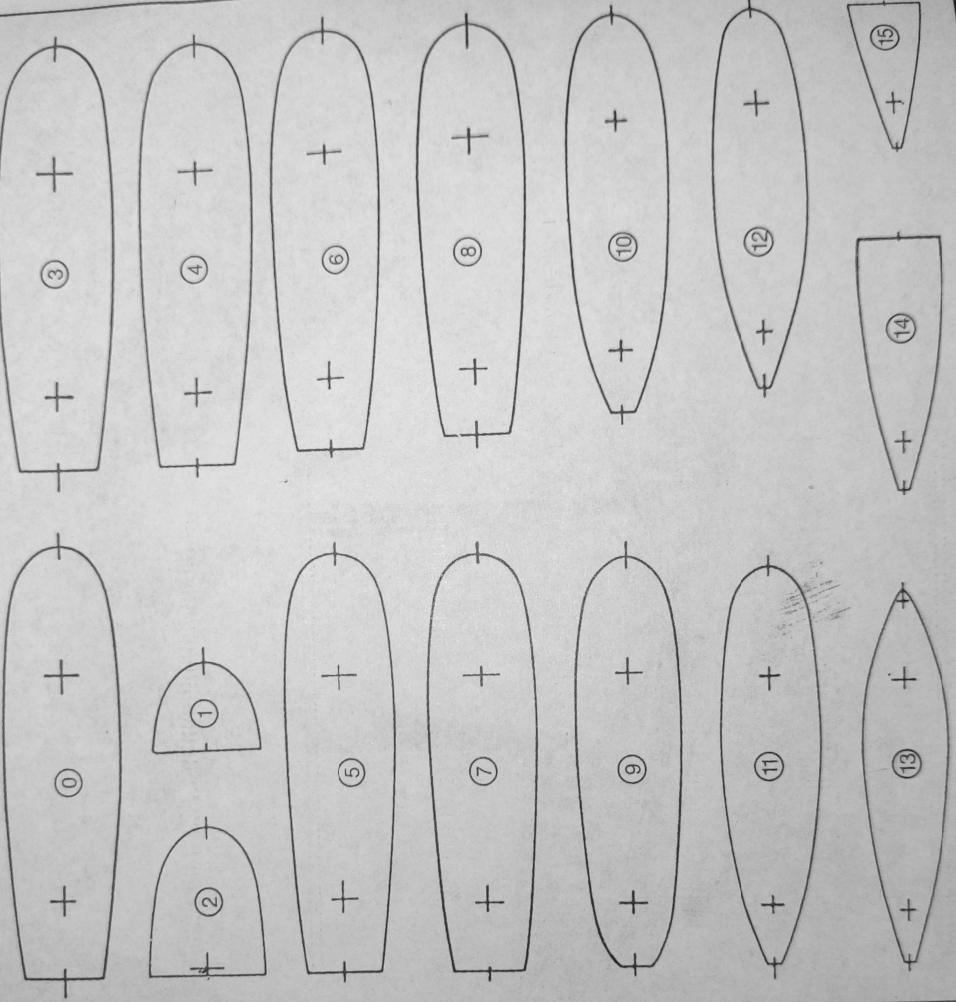
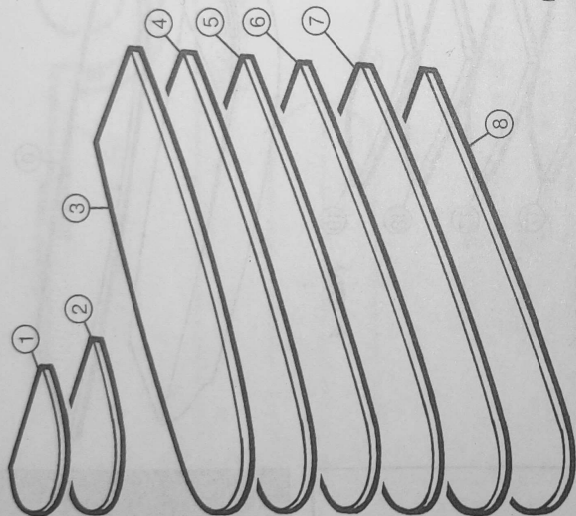

FIG. 1



A

Prepare pieces 0 to 19 (0.6 mm. plywood) being careful to number them as in designs A and B.

Pieces 16 and 17 include two pieces each.

They will be used to form the stern quarter-deck (see design C).

FIG. 2

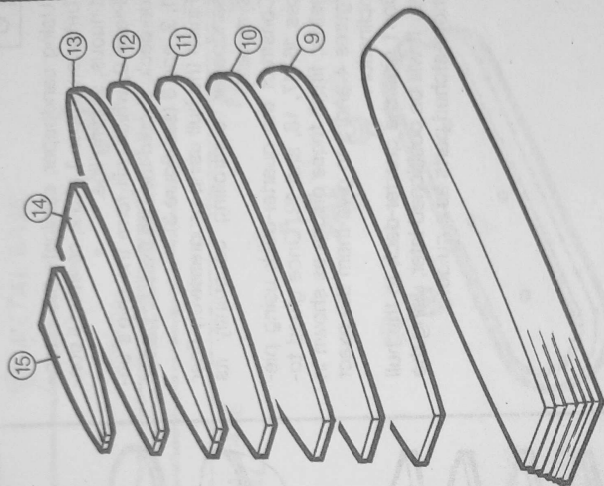

B

Before gluing the pieces, check carefully how and where they will be positioned. Pieces 1 and 2 determine the inclination of the hull at the bow. They should be glued to each other then positioned on number 3 (see figure 1).

Pieces 13, 14, and 15 form the lower part of the hull. It is advisable to divide them in two parts, following the line etched lengthwise. The metal keel 21 will be placed in this groove (see figure 2). Follow the designs and the photographs.

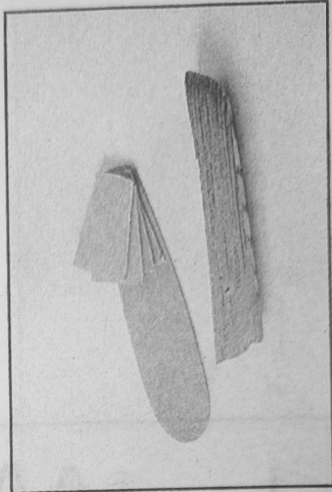
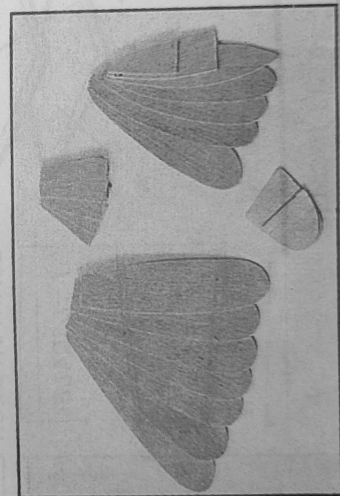

**C**

Using sandpaper, eliminate the «step» between pieces 1 and 2, creating a continuous, sloping line.

Piece 0, which will form the ship's underdeck, should then be fixed to pieces 1, 2, and 3 (see figure 3).

Finish the hull using progressively finer sandpaper, controlling constantly its symmetry.

Construct the quarter-deck using pieces 16, 17, 18, and 19. Once glued together, finish these pieces as shown in figures 4 and 5 to give them the exact inclination.

Don't glue the quarter-deck to the hull yet. It will be positioned later, using the photo-etched parts as a guide.

**FIG. 3****FIG. 4****STERN  
QUARTER DECK****FIG. 5**

FIG. 6



**D**

Detach the photo-etched parts from the frames only as they become necessary. Use a cutter, then finish with a small file (see figure 6). Prepare as in figure 7 the metal base 20 and the keel 21 (0.5 mm. brass). Finish carefully the metal base, polish it with an abrasive paste. Attach it to the wooden base 22. Make the holes for the brass columns 23, 24, 25, and 26 (see figure 8). (N.B.) At this point, glue only side columns 23 and 24. The position of the holes in the hull will be determined by these lateral columns.

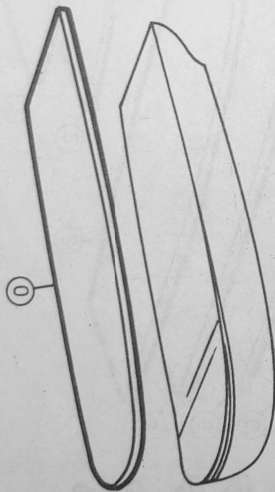
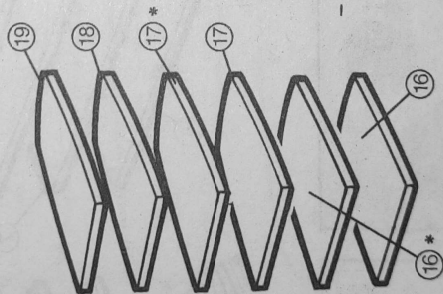
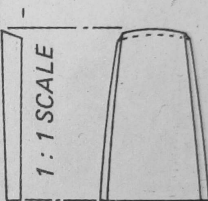
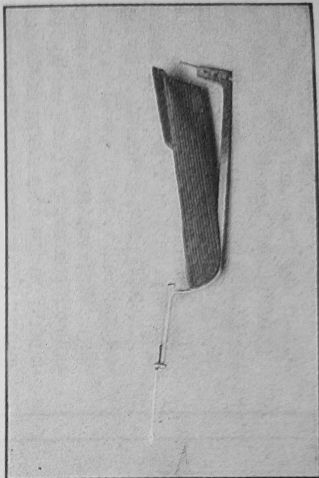
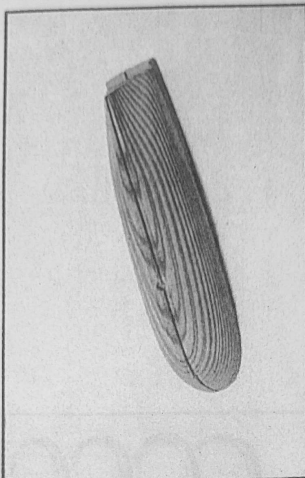
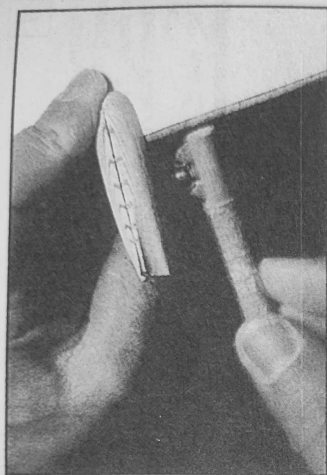
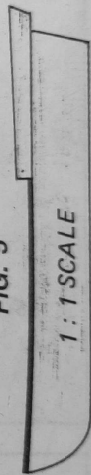
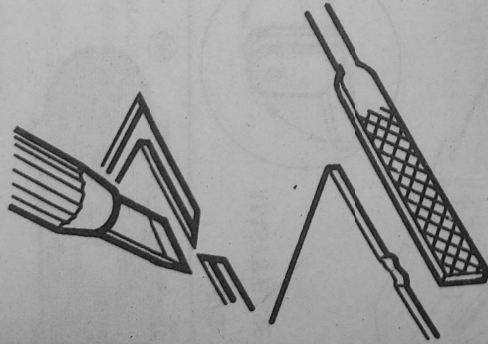
FIG. 7

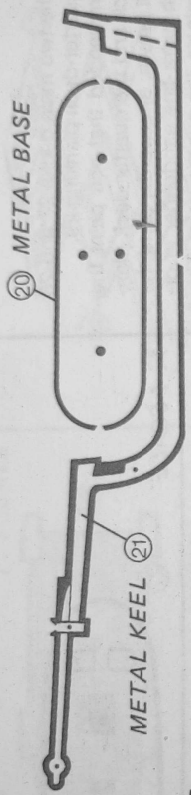

1 : 1 SCALE

FIG. 9

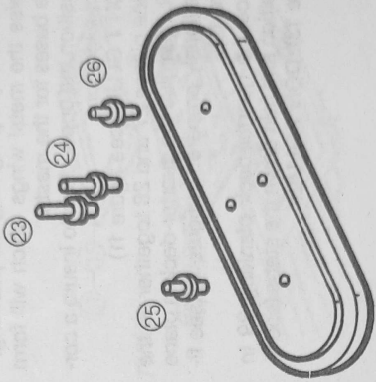

WOODEN BASE  
1 : 1 SCALE

FIG. 8

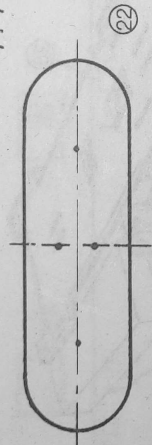

2 : 1 SCALE

**ATTENTION!**  
Shorten columns 25 and 26 on which will rest keel.  
One of these two columns should be slightly shorter than the other since the keel is not parallel to the base.

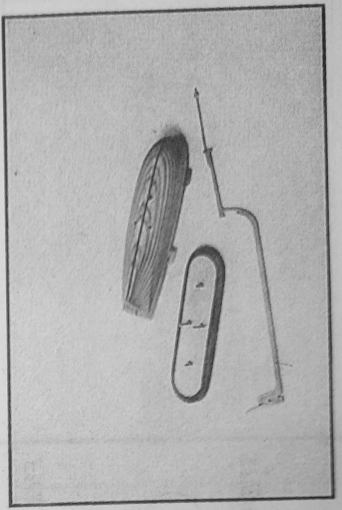
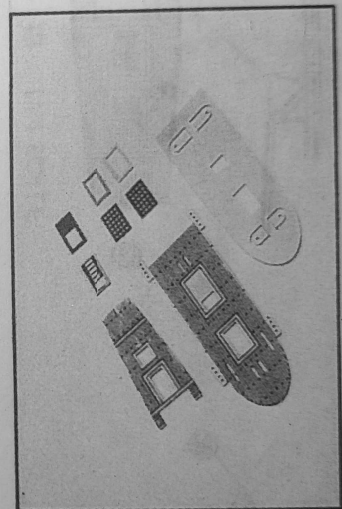
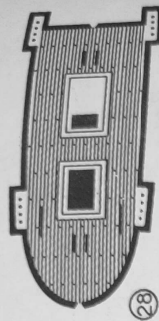

FIG. 10



1 : 1 SCALE



28

FIG. 11

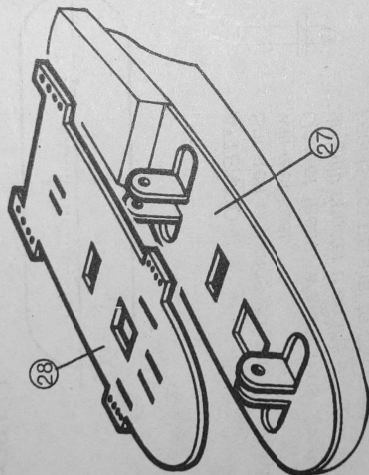

FIG. 12

MASTS BASE

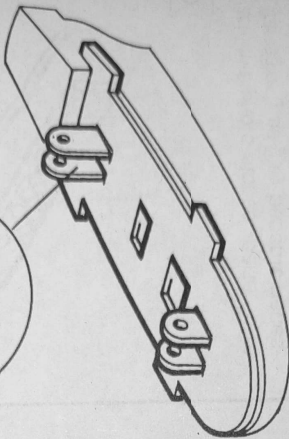
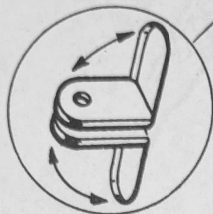
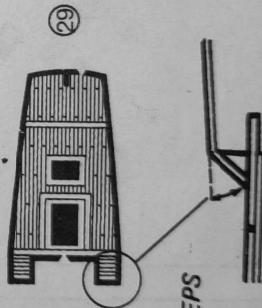
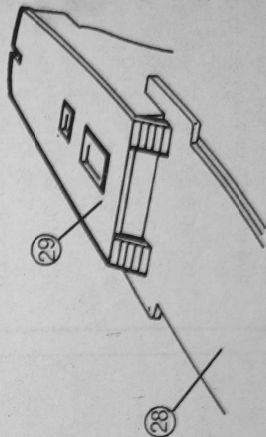

FIG. 13 1 : 1 SCALE



STEPS

FIG. 14



E

Prepare the two main decks 27 and 28 and the quarter-deck planking 29.

It is recommended that you paint the upper deck and the quarter-deck planking a dull brown; afterwards, sand the decks with extra-fine sandpaper in order to eliminate the excess paint. The brown should remain only in the grooves, thereby highlighting the planking. Raise the metal wings which will form the bases for the masts.

Position the upper deck to insure a correct alignment.

**DON'T GLUE!** (see figure 11)

Place pieces 27 and 28 together on the hull, then glue the quarter-deck in place (previously prepared in figure 4) (see figure 12).

Place the quarter-deck planking 29 in position and fold down the steps (see figure 13). **DON'T GLUE!**

F

Glue all the superstructures illustrated in the design onto the decks.  
N.B.) Use the decks as a guide to perfecting the finish of the hull (see figures 15 and 16).

FIG. 15  
1 : 1 SCALE

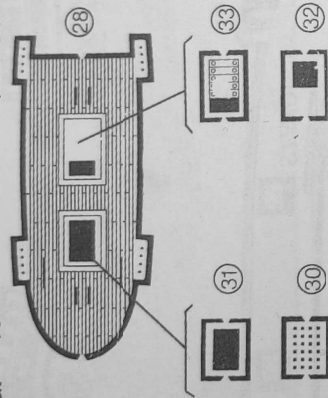

G

On the wooden deck 0, mark the position of the gratings 30 and 34 and of the hatch 32. Paint the wooden deck a dull black to create a greater sense of depth.

FIG. 16  
1 : 1 SCALE

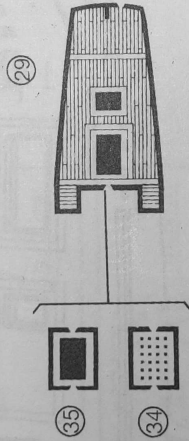

H

Glue the main deck to the hull.  
The quarter-deck planking 29 will be glued later, after having checked the junction between hull, quarter-deck, and bulwark.

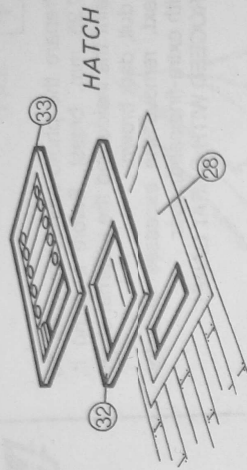

HATCH

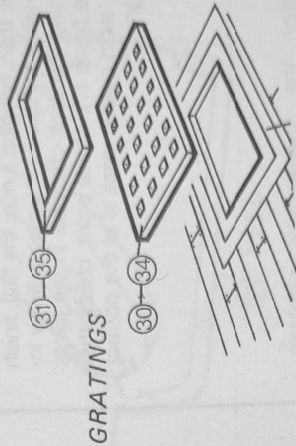

GRATINGS

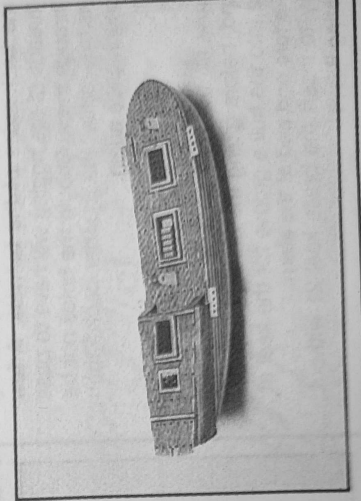
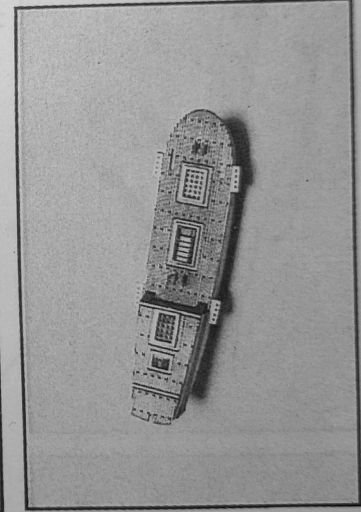

1

Prepare the photo-etched bulwark 36 (0.25 mm. brass). Before bending it, paint the inside and the external stripe a dull, dark brown.  
Next, remove the excesses of color with extra-fine sandpaper.

**PROCEED WITH GREAT CARE!**

Bend the bulwark around a wooden dowel, then, bringing it near the hull, finish bending it. Position it temporarily by inserting the deck channels in the joints (see figure 17). At this point, check that the stern quarter-deck is at the correct height.

Position the quarter-deck planking, then check that the holes in the bulwark are visible from the inside by squeezing the back sides of the bulwark. A few threads of the rigging will have to pass through them. Should the holes not be visible, refile the quarter-deck, then check once again.

Now fix the quarter-deck planking 29 and, before gluing the bulwark 36, carve into the hull a groove for the keel at the fore end and at the stern.  
Try to insert the brass keel 21 without gluing it.

1 : 1 SCALE



PHOTO-ETCHED BULWARK

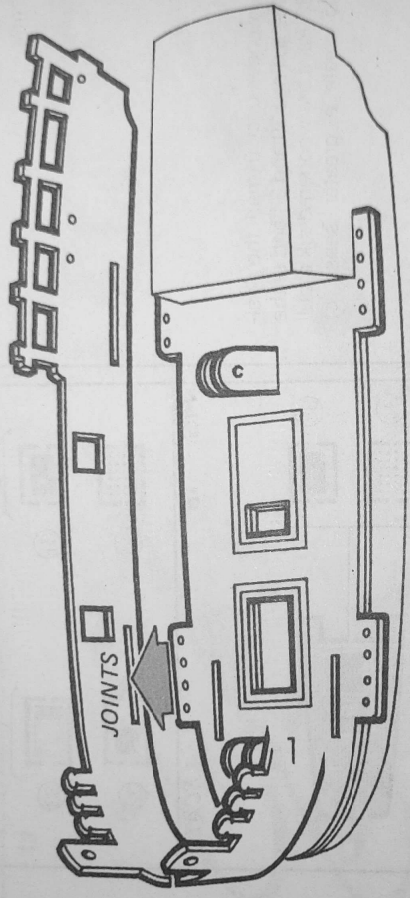

FIG. 17

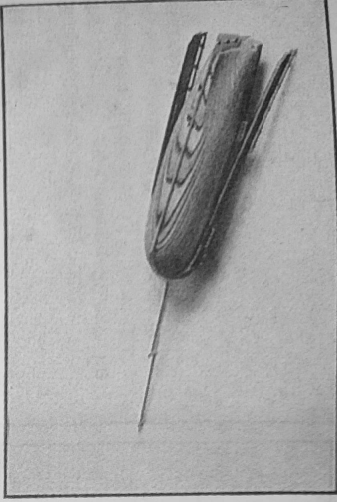
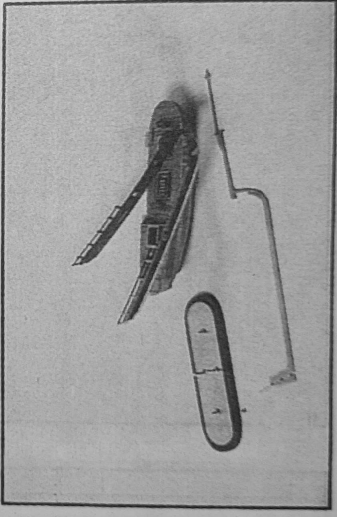
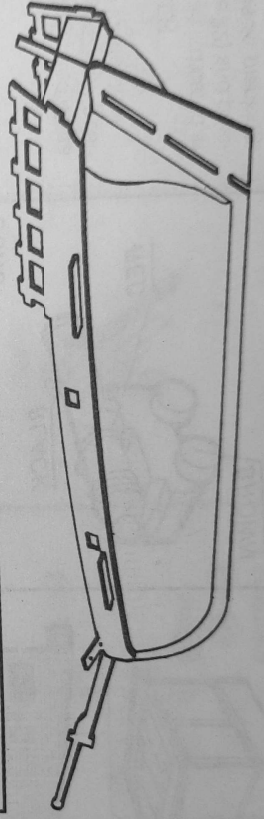
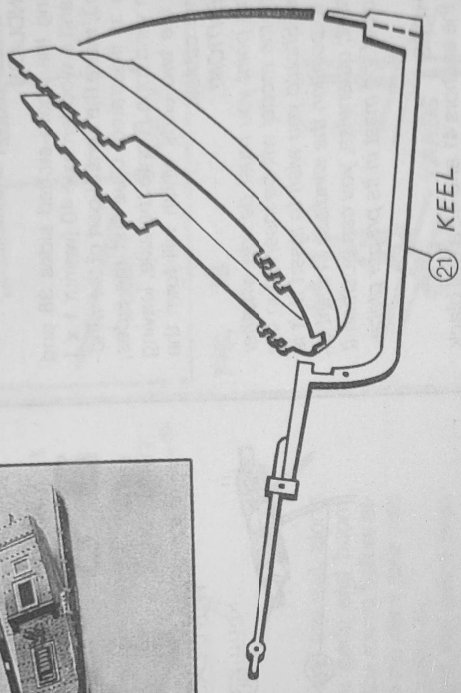
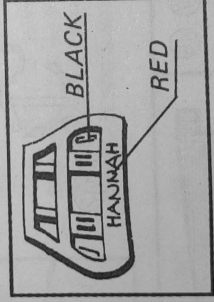
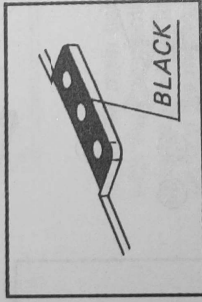
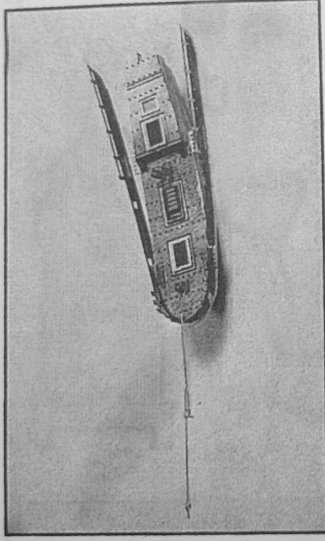



FIG. 18



L

Glue the bulwark 36 to the hull and attach the keel 21 by first inserting it in the joint in the bulwark (see figure 18 and the photos). Position the transom 37 and glue it to the sides of the bulwark and to the quarter-deck. If necessary, finish again the rear part of the wooden quarter-deck (see figure 19).

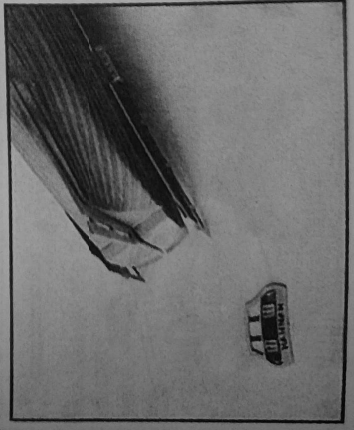

FIG. 19

**M**

Proceed to the preparation of the superstructures: windlass, anchors, cannons, deck house, and tiller.

**WINDLASS**

Using the photo-etched sides 38 and 39 and a wooden axle 40 (walnut 1 x 1 mm.), make the central part of the windlass as illustrated. Glue first the sides, then wind rope R onto the axle, leaving free the two ends which will form the anchor cables.

**ATTENTION!**

At this point you must decide whether or not the model will be inserted in the bottle. Should you wish to insert it, it is best to position the windlass in front of the mast; otherwise, you can position it in back of the mast in its proper place.

**ANCHORS**

Paint the anchors 41 and 42 a dull black or a dark metallic color. Pass the ends of the anchor cables R through the hawse-holes; tie each end to the ring of the anchor. The anchor will be fixed to the catheads using the eyebolts 43 and 44 (see figure 20).

**CANNONS**

Paint the cannons 45, 46, 47, and 48 as indicated in the instructions, then position them and glue them to the deck.

**DECK HOUSE AND TILLER**

Paint the deck house 49 as indicated in the instructions (see figure 22) and position it on the quarter-deck planking. Glue the tiller 50.

**FIG. 20****FIG. 21****CEMENT ON THE DECK****DECK HOUSE****FIG. 22**

FIG. 23



To avoid an excessive number of knots, it is advisable to proceed to the soldering of the ends of the rope in the illustrated manner.

**N**

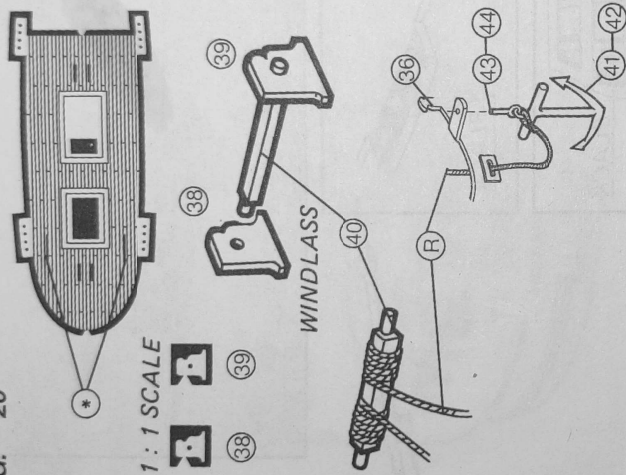
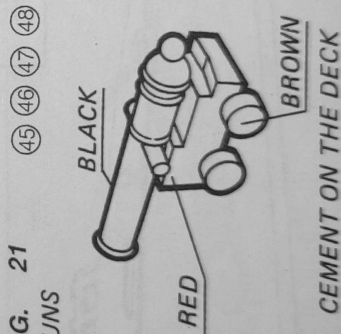
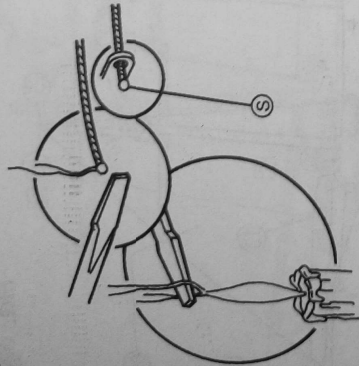
Detach from the frame (0.5 mm. brass) all parts belonging to the masts and yards, and paint them in the following way:

- masts and bowsprit ..... dull white
- gaffs, boom, yards ..... dull black
- crosstrees and caps ..... dull black

FIG. 24

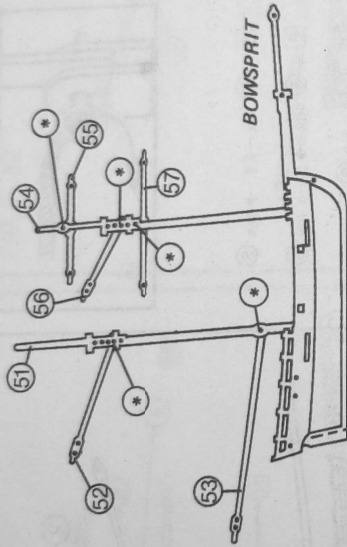

N.B.) The main sail and top sail, along with their respective gaffs and boom, may be attached to the masts before attaching the masts to the deck (see also figure 31 and 34 on page 13). The asterisks indicate the exact position of each hole to be used. **BE CAREFUL!** For this stage, use thread R and follow the figures.

FIG. 26

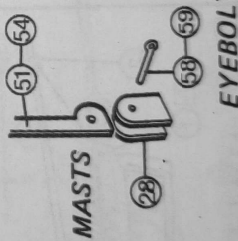

FIG. 27



FIG. 28

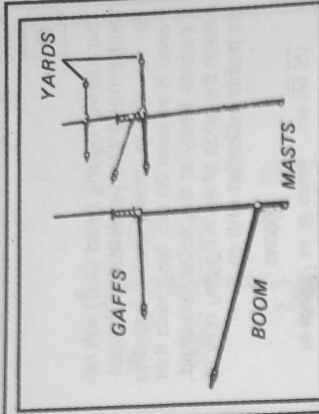
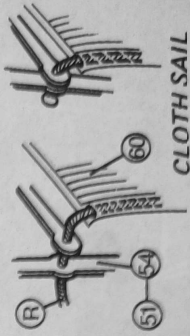
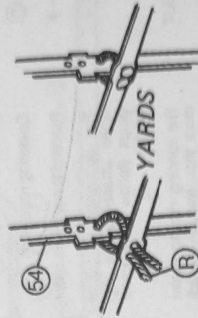

FIG. 25



**O**

The running rigging (read OUT) will raise the masts and yards inside the bottle. For this purpose, make sure the thread is at least 20 cm. long, and that it passes freely at the holes indicated. Attach the ends of each rigging only at the points indicated with an S.

**LEGEND**

- A B** etc. Refers to the riggings to be attached
- Dx** Right side of the ship (illustrated)
- Sx** Left side of the ship
- S** Soldering rope ends
- Proceed in numerical order
- 1-2-3** The sequence to follow when attaching the riggings (follow very carefully)
- OUT** The running rigging (leave more than enough thread)
- M** Attach to eyebolt 58 or 59

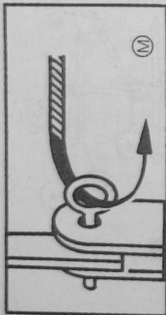

- A = S** 1dx → 2 → 1sx **S**
- B = S** 4dx → 5 → 4sx **S**
- C = S** 7 → 8 **S**
- D = S** 10 → 11 → OUT
- E = S** 13 → M → 15 FIG. 30

**FIG. 29**

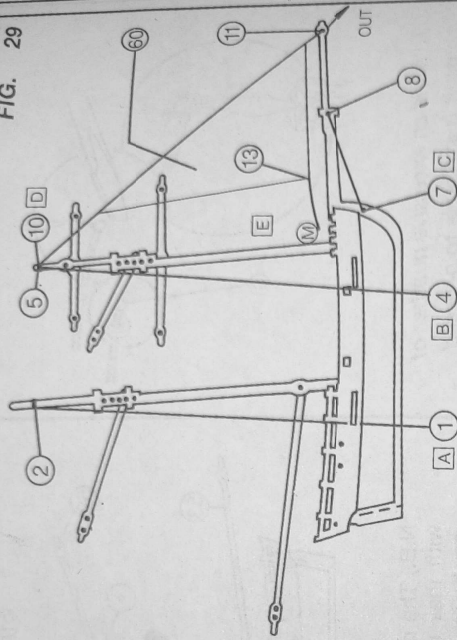

**FIG. 30**

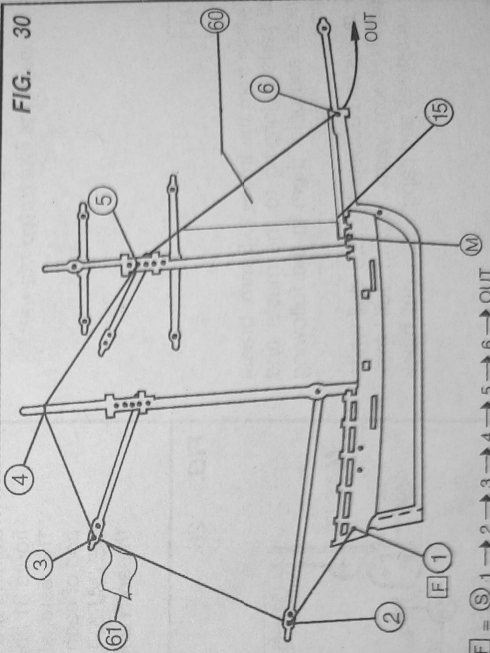

**Example of figure 29 A**

- A = S** 1dx → 2 → 1sx **S**

**Signifies:**

Solder the rope on the lower part of the right channel at point 1, then proceed in order to point 2 (mast), then insert the rope in point 1 on the left channel, then sold the rope end.

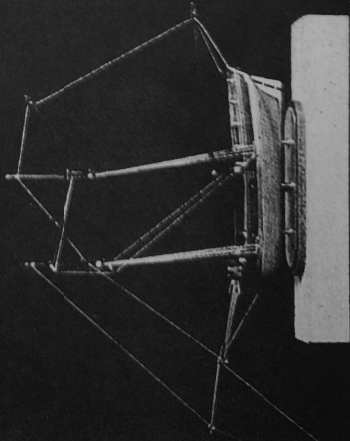

FIG. 31

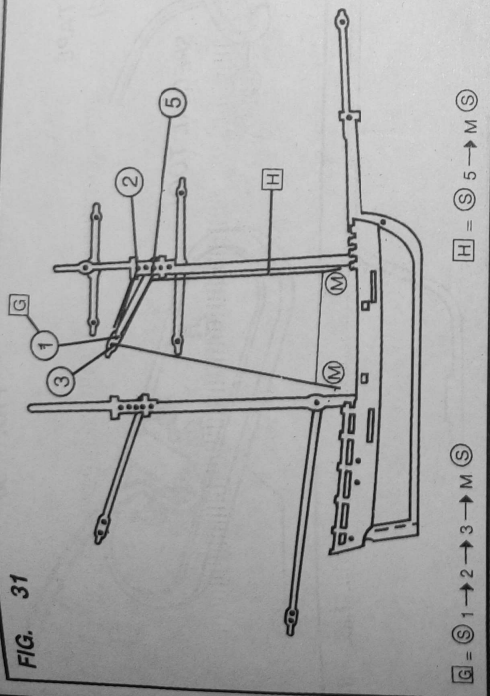

FIG. 33

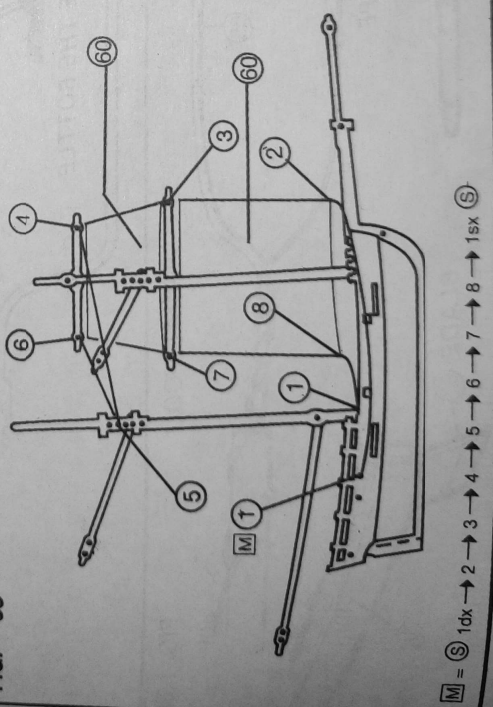

FIG. 34

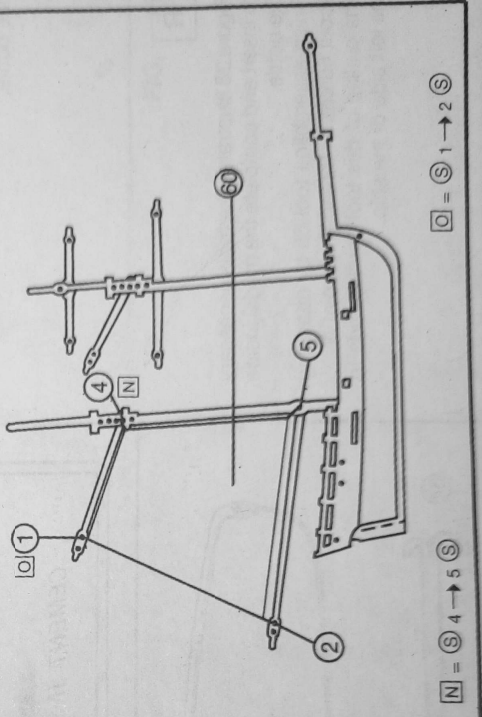
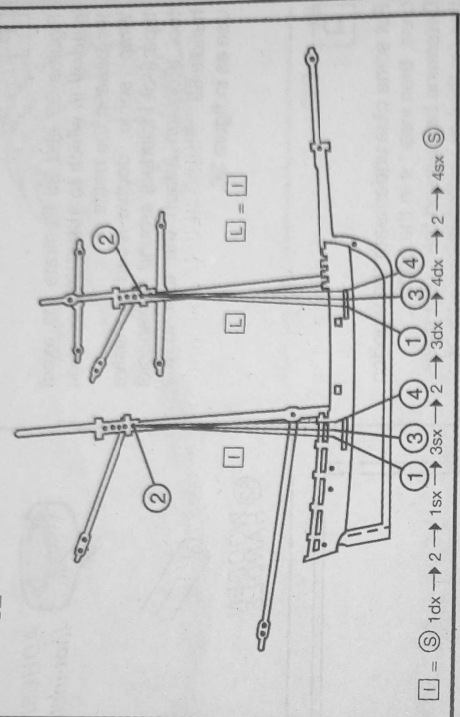

FIG. 32



**P**

Figures 35 and 36 illustrate the exact manner in which to insert and position the base in the bottle. Wrap some double-faced adhesive tape (not included) around the special tool 63, then attach the tool to the handle 62. Use as in figure 36.

**Q**

Put some glue underneath the wooden base, then insert it in the bottle. Determine beforehand the exact position for the base by comparing the model's dimensions with the exterior of the bottle.

**R**

Figure 38 illustrates the tools necessary to insert and complete the model inside the bottle. Finish assembling tool 65 by attaching about 60 cm. of thread R at point A. The outline of this tool corresponds to the left side of the ship.

FIG. 36

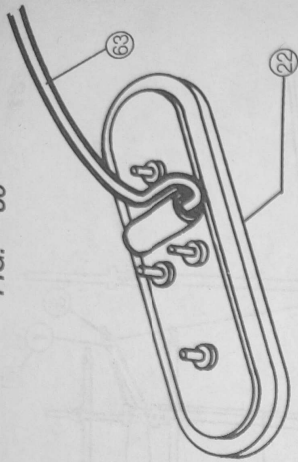

FIG. 35

ADHESIVE TAPE  
(not included)



FIG. 37

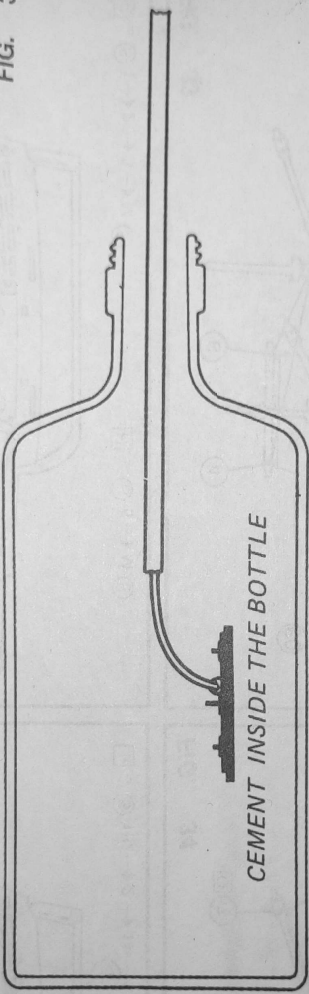
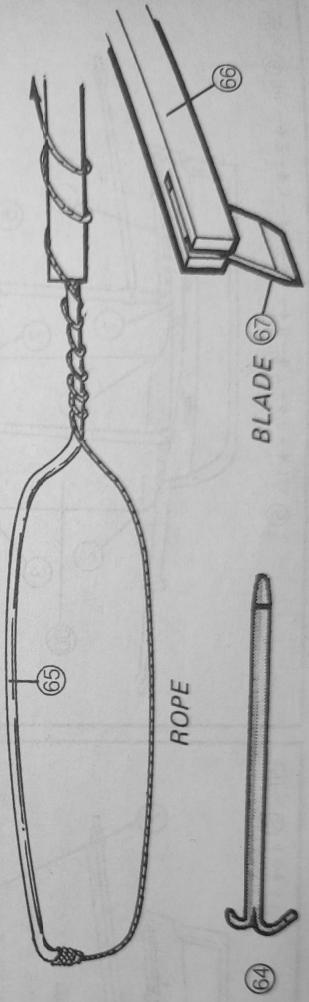

FIG. 38

SPECIAL TOOL



ROPE

64

BLADE 67

66

FIG. 39

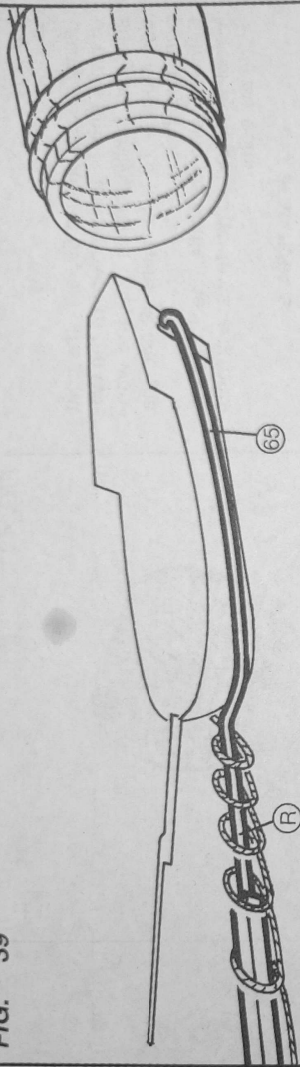

**S**

Rest the model's channels against tool 65 and then pass point A of the tool (with thread R) through the highest opening between the rudder and the keel, then passing the thread along the right side of the ship, underneath the channels.

Wrap the remaining rope around the tool and even around the handle (see figure 39).

**T**

Place some glue in the holes under the hull.

With great caution, pass the model across the neck of the bottle, taking great care of the sails and masts (see figure 40). Position the ship on its base, making sure to glue it perfectly.

Unwrap the thread from tool 65, then remove thread and tool carefully from the bottle.

FIG. 40

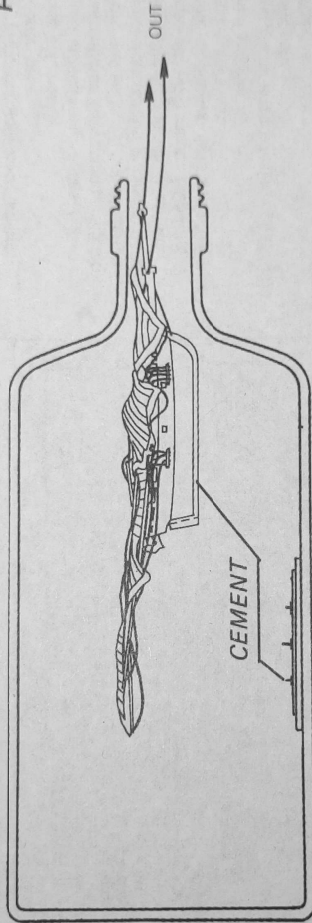

**U**

Pull the ends OUT which raise the masts and yards (see figure 41).

Using the tool 62 and its respective handle 62, position the yards and pull taut the rigging. Attach the thread R at the indicated points, then with the blade 67 and its handle 66, cut the segment of thread left over.

FIG. 41

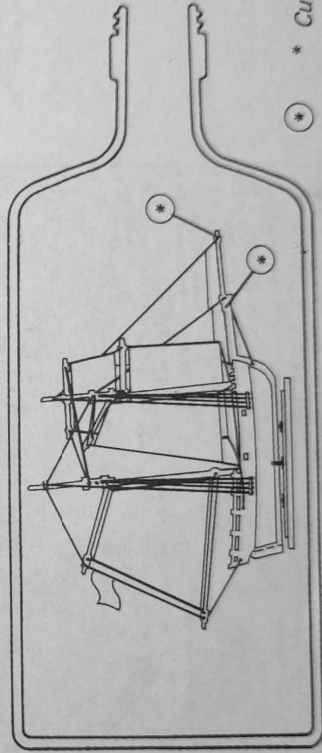

\* Cut using blade 67

Using pieces 68 and 69, affix the coat of arms (this is the emblem of the Washington family); attach it to the wooden stopper 70 (see figure 42 and the photographs).

Before closing the bottle, check carefully your work and do not forget any tools inside the bottle.

#### LIST OF MATERIALS

- 0 - 19 Plywood for hull, 0.6 mm.  
 20 Photo-etched metal base, 0.5 mm.  
 21 Photo-etched metal keel, 0.5 mm.  
 22 Wooden base  
 23 - 26 Brass columns  
 27 - 29 Photo-etched metal decks, 0.25 mm.  
 30 - 31 Photo-etched fore grating, 0.25 mm.  
 32 - 33 Photo-etched fore hatch, 0.25 mm.  
 34 - 35 Photo-etched stern grating, 0.25 mm.  
 36 Photo-etched bulwark, 0.25 mm.  
 37 Photo-etched transom, 0.25 mm.  
 38 - 39 Photo-etched windlass sides, 0.5 mm.  
 40 Walnut, 1 x 1 mm.  
 41 - 42 Metal anchors  
 43 - 44 Eyebolts for anchor fastenings (4703)  
 45 - 48 Metal cannons  
 49 Metal deck house  
 50 Photo-etched tiller, 0.25 mm.  
 51 - 57 Photo-etched masts and yards, 0.5 mm.  
 58 - 59 Eyebolts for fastening the masts (4703)  
 60 Printed sails  
 61 Printed flags  
 62 Tool handle  
 63 Tool  
 64 Tool  
 65 Tool  
 66 Blade handle  
 67 Blade  
 68 Photo-etched base for coat of arms, 0.25 mm.  
 69 Photo-etched coat arms, 0.25 mm.  
 70 Bottle stopper  
 R Special thread  
 Bottle

FIG. 42

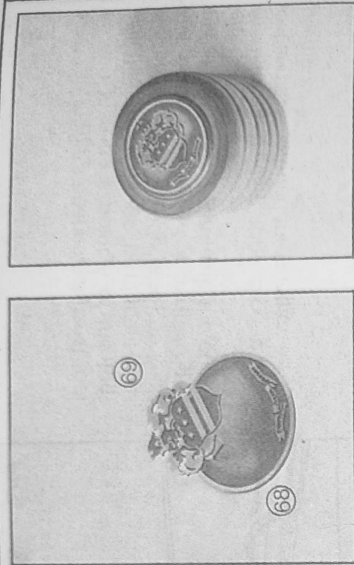

WOODEN STOPPER

