

DECALS AND RESIN FOR THE HOBBY ENTHUSIAST

DEKLS II
FOR THE ENTHUSIAST

TELSTARS

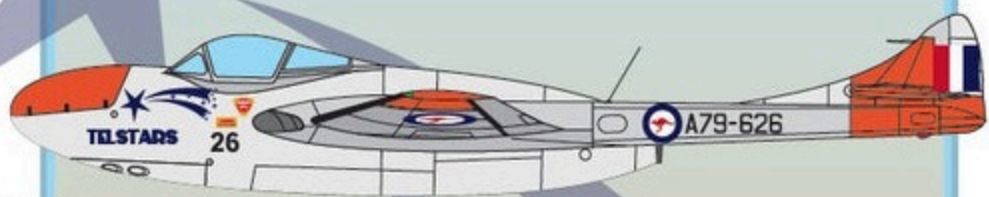
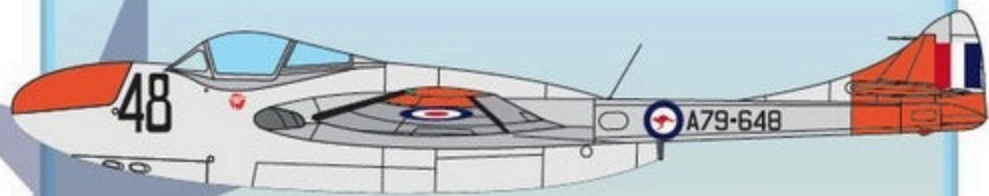

1/48 Scale
RAAF Vampire
Telstars Aerobatic Team
1963-1967 Schemes

Decals to complete 2 models

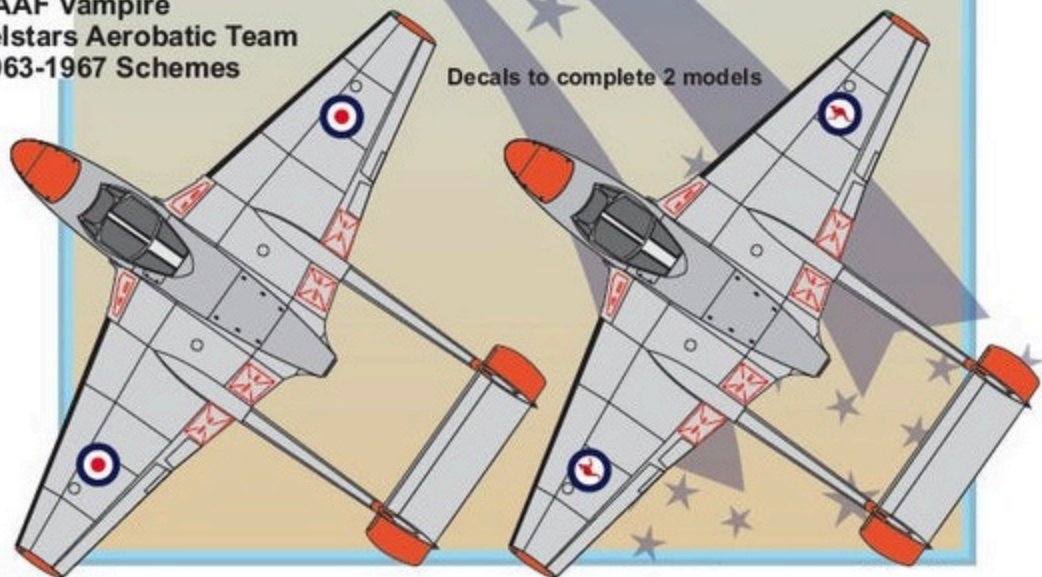

PROUDLY
AUSTRALIAN

DL-48013



 **SOUTH**
AUSTRALIA

TELSTARS

Circa 1963

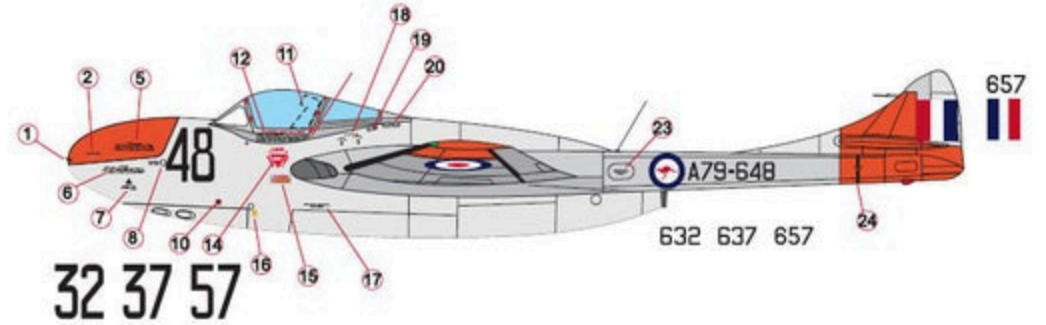
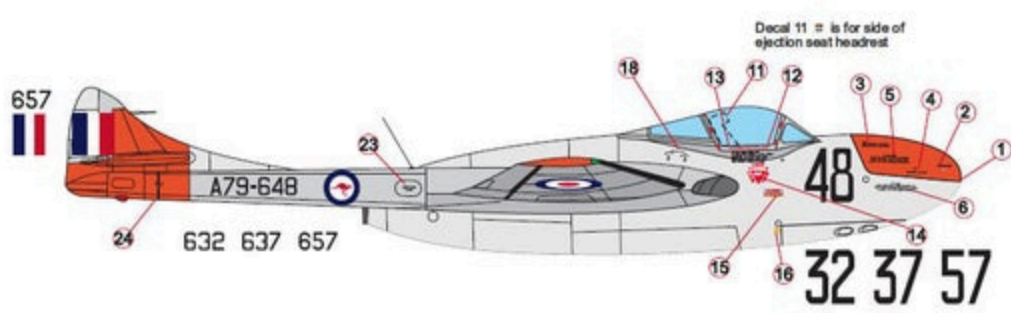

Canopy frame decal

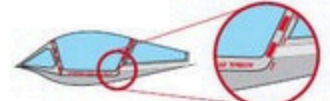
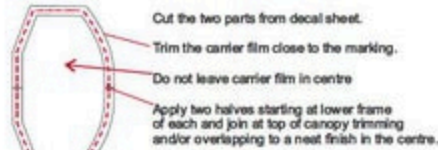

Canopy detail. Indicative only. Arrow markings may not be present on some aircraft. If broken lines are applied, they varied in length/spacing depending on paintshop that last re-marked the frame.

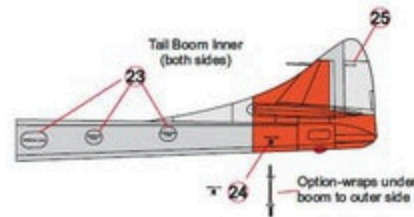
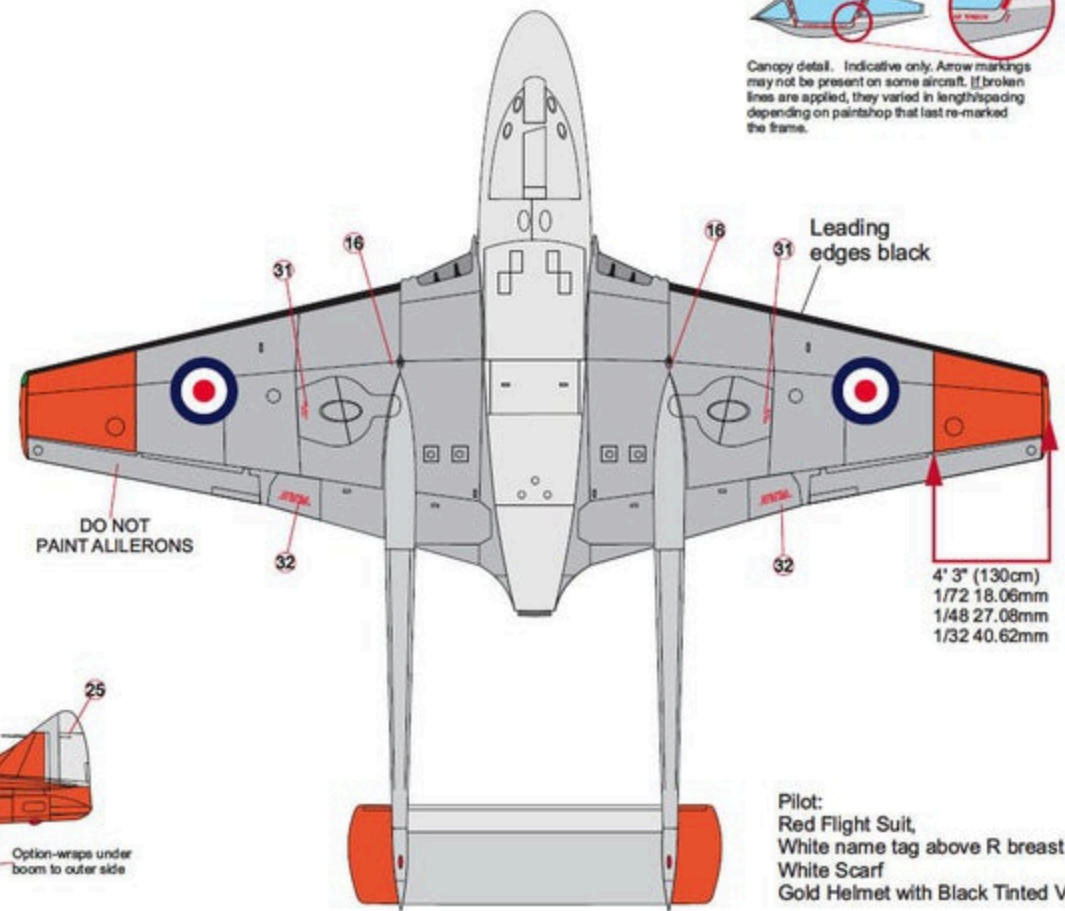
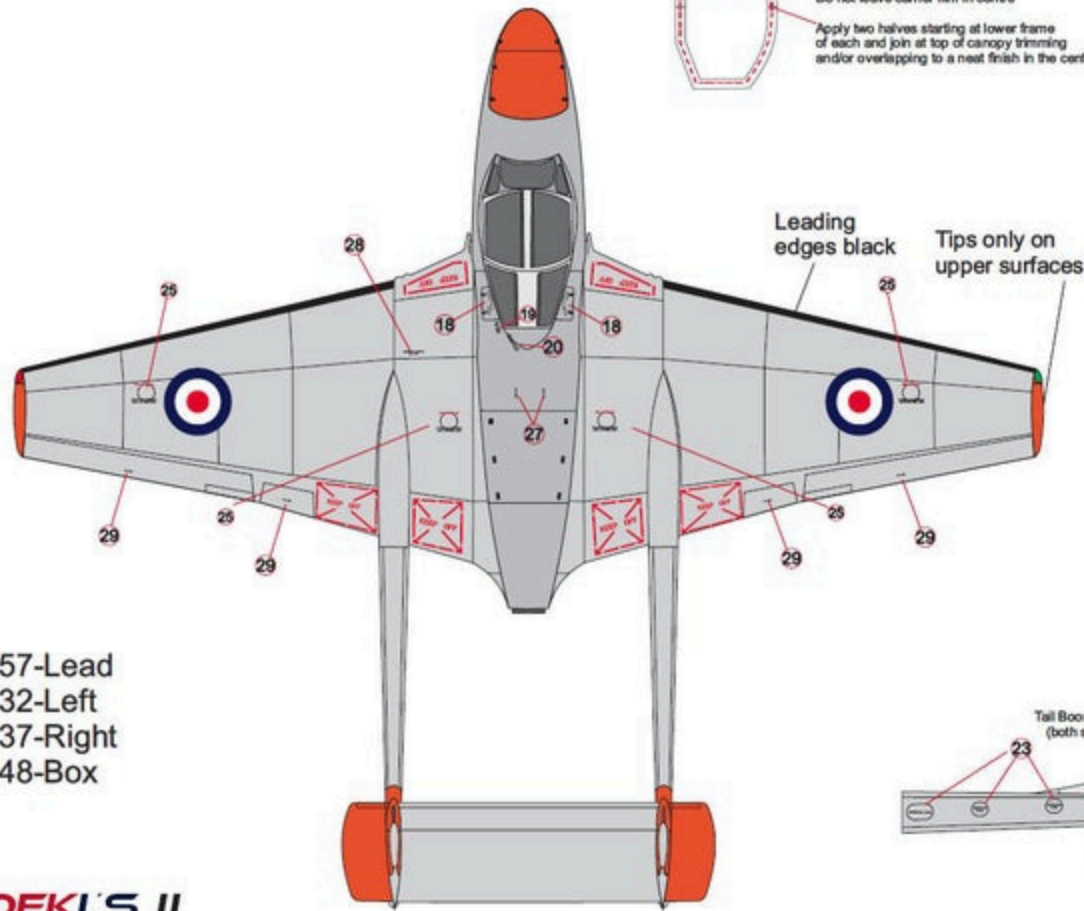

Pilot:
Red Flight Suit,
White name tag above R breast pocket
White Scarf
Gold Helmet with Black Tinted Visor

TELSTARS

Circa 1967

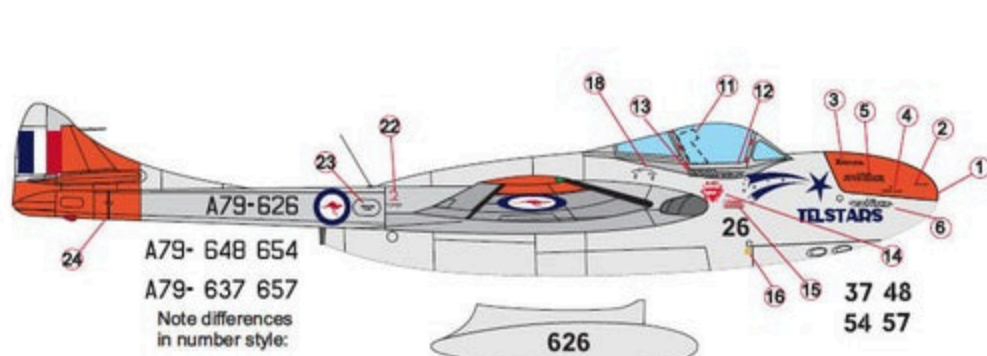

A79- 648 654
A79- 637 657
Note differences
in number style:

637 654
648 657

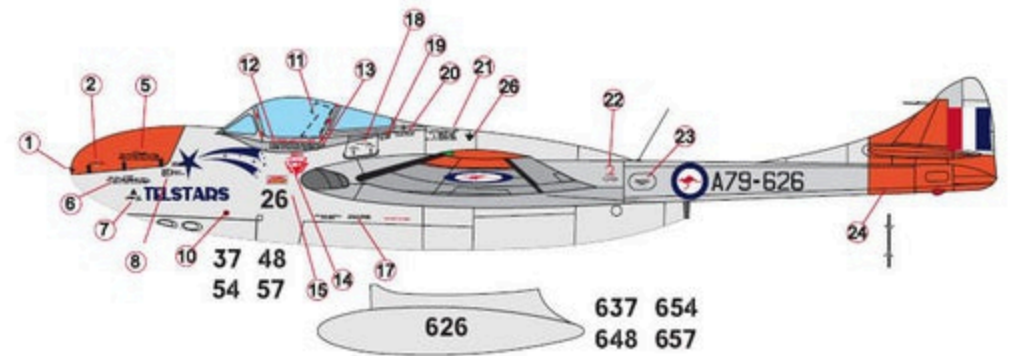

637 654
648 657

Canopy frame detail

- Cut the two parts from decal sheet.
- Trim the carrier film close to the marking.
- Do not leave carrier film in centre
- Apply two halves starting at lower frame of each and join at top of canopy brimming and/or overlapping to a neat finish in the centre.

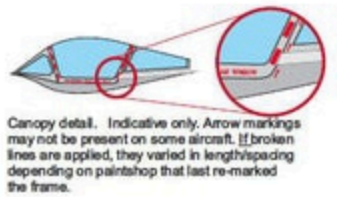
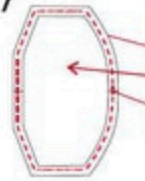

Canopy detail. Indicative only. Arrow markings may not be present on some aircraft. If broken lines are applied, they varied in length/spacing depending on paintshop that last re-marked the frame.

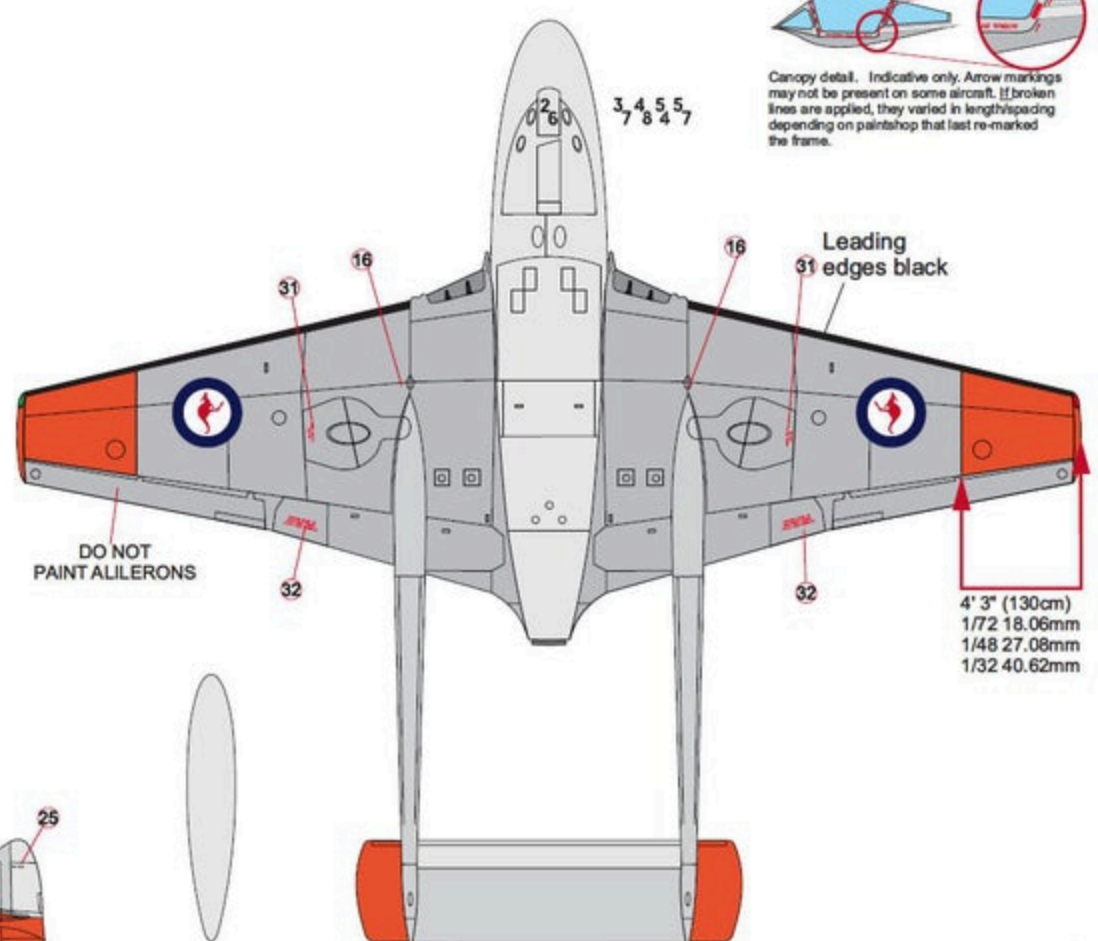
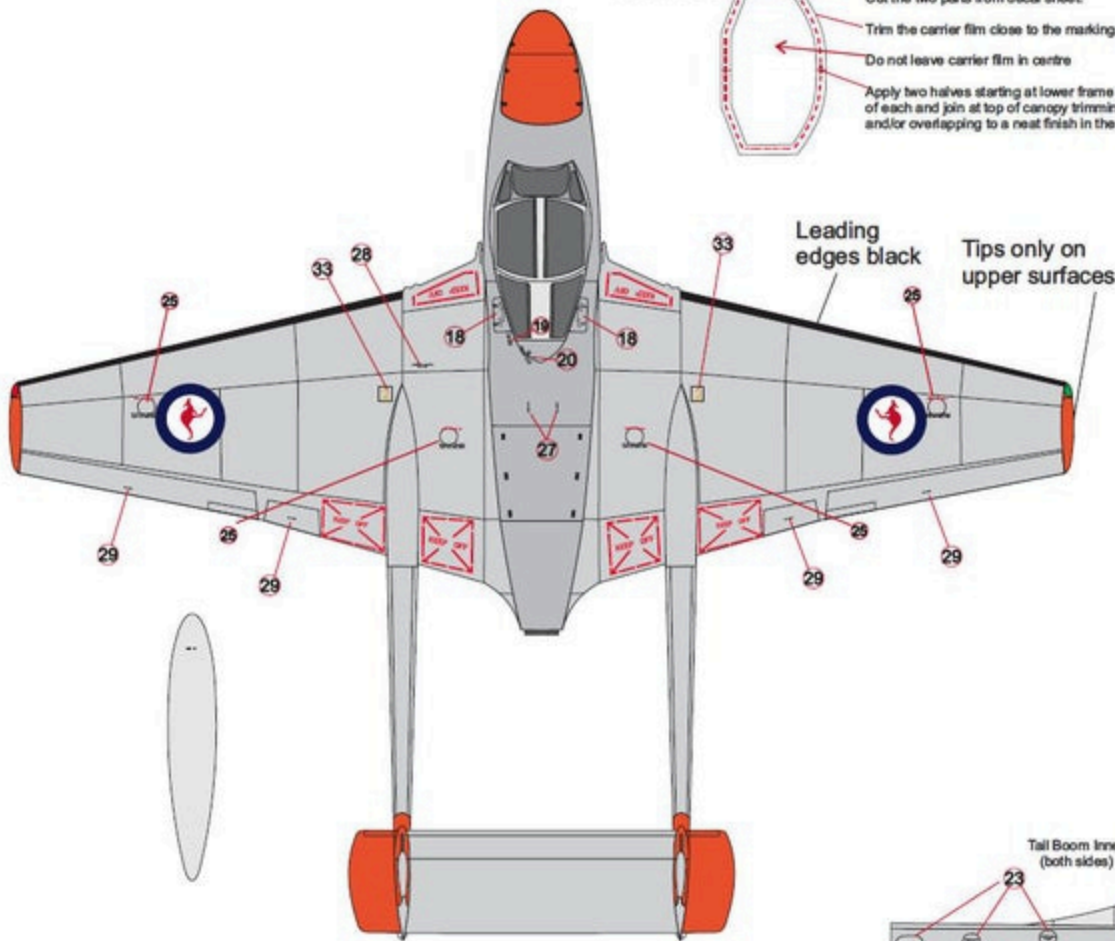

DO NOT PAINT ALILERONS

4' 3" (130cm)
1/72 18.06mm
1/48 27.08mm
1/32 40.62mm

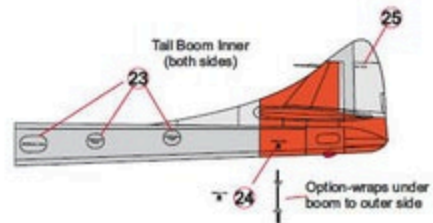

DH VAMPIRE

STENCIL DATA PLACEMENT AND PAINT GUIDE

Decal 11 is for side of ejection seat headrest

Options

Options

Decal 11 is for side of ejection seat headrest

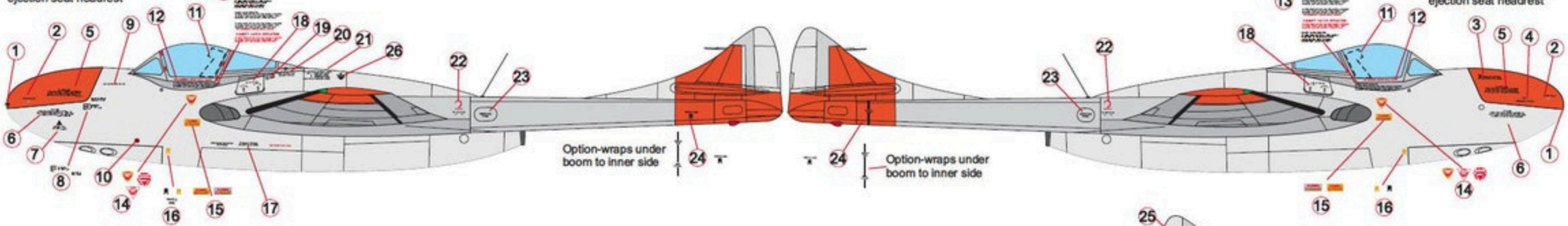

Option-wraps under boom to inner side

Option-wraps under boom to inner side

Option-wraps under boom to outer side

Tail Boom Inner (both sides)

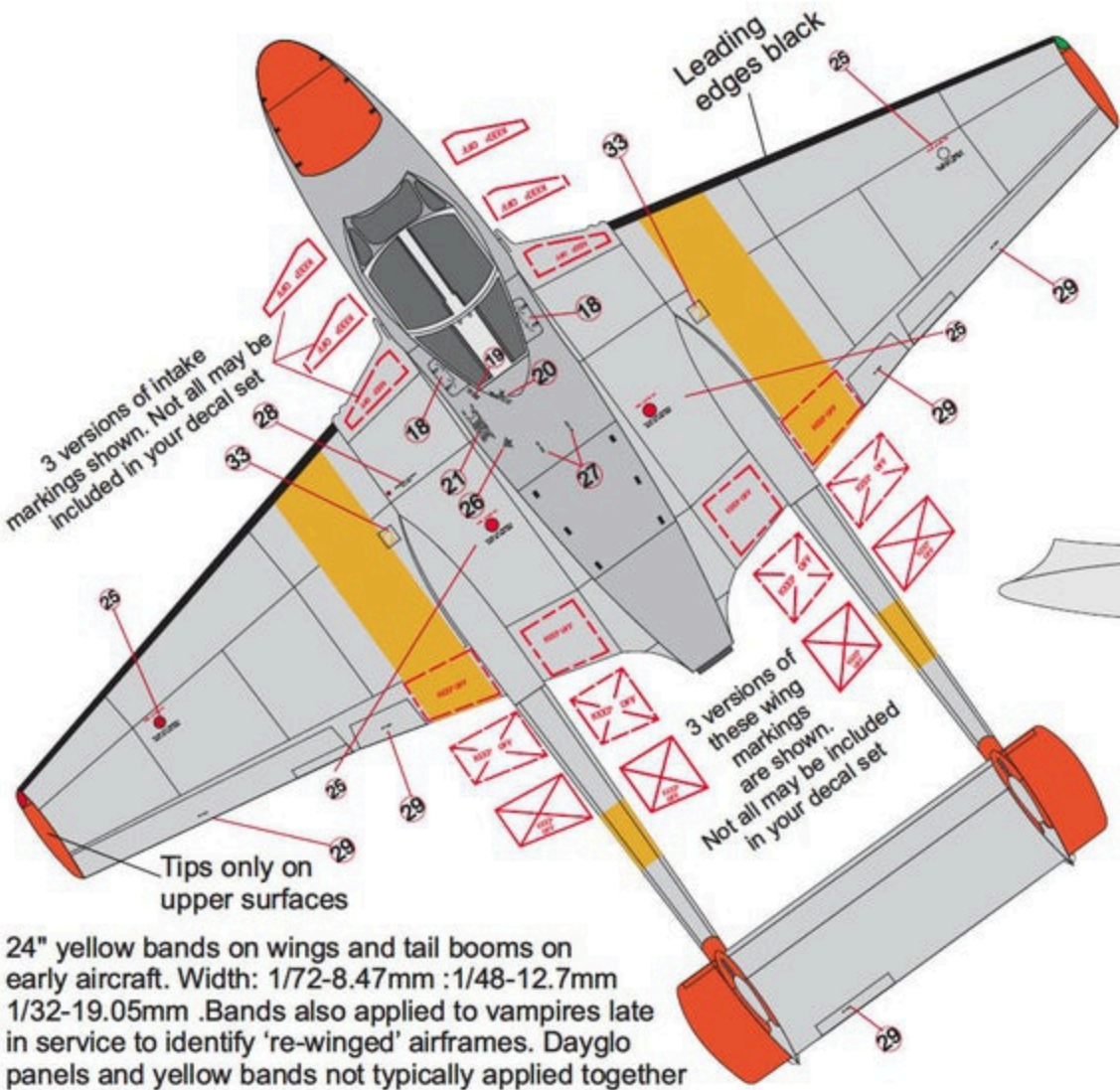

24" yellow bands on wings and tail booms on early aircraft. Width: 1/72-8.47mm : 1/48-12.7mm 1/32-19.05mm .Bands also applied to vampires late in service to identify 're-winged' airframes. Dayglo panels and yellow bands not typically applied together

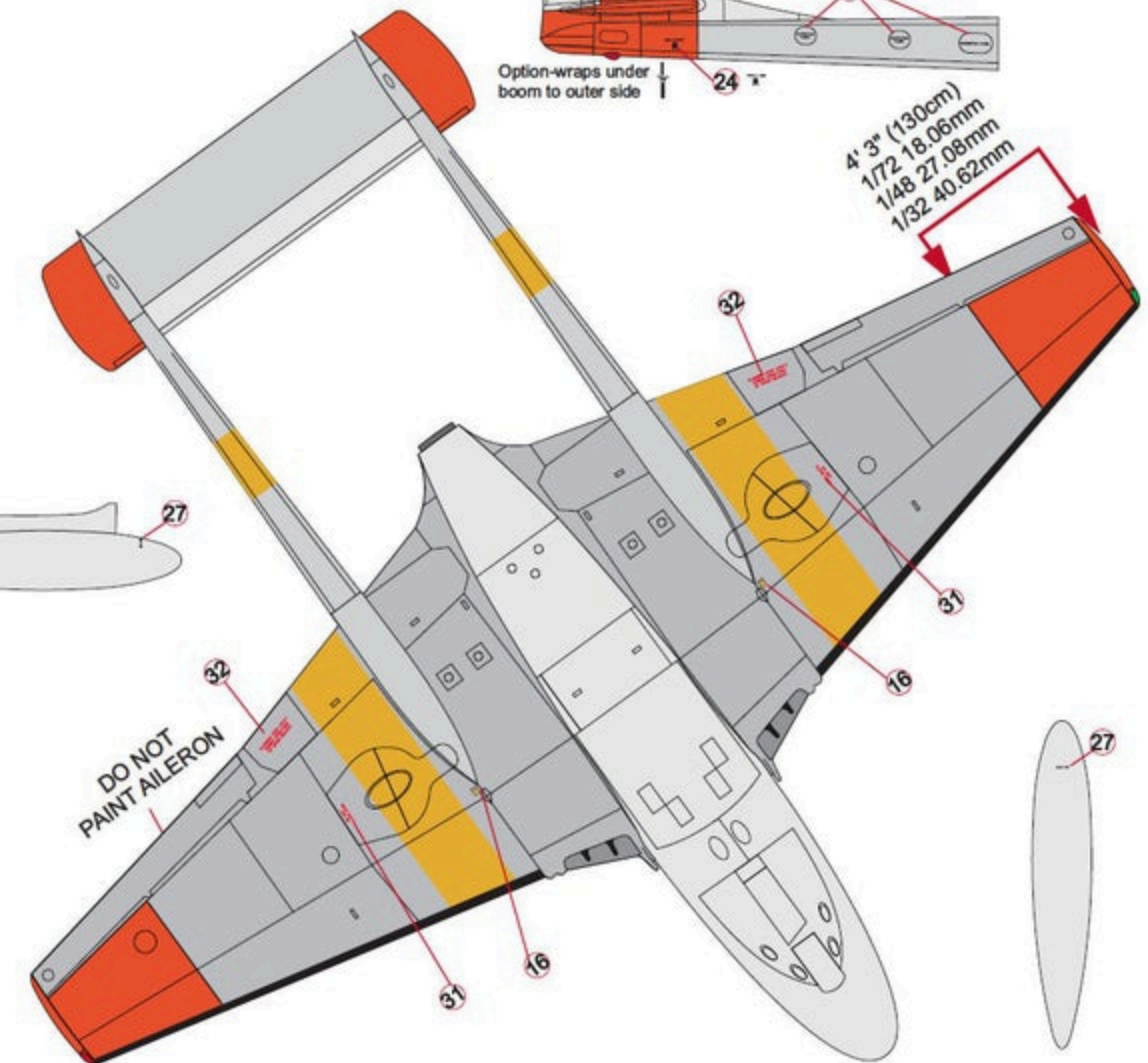

DO NOT PAINT AILERON

4' 3" (130cm)
1/72 18.06mm
1/48 27.08mm
1/32 40.62mm